



SELECT SHAKE

Fixing Guide

October 2023



Westlake
Tapco® Europe Ltd.

– Contents –

	PAGE
Product Information	3
No Special Tools Required	3
Storing the Product	3
Product Description	3
Ratings and Certification	4
Leadwork	4
Recycling	4
BS 5250 Guidance on Roofing Membrane/Underlay	5
Installation Guidelines	6
Note to Installer	6
Job Site Ready!	6
Roof Deck	6
Drip-edge (Dry Verge & Gutter)	6
Roof Membrane/Underlay Use	7
Fasteners	8
Getting Started	8
Straight Coursing	8
Staggered Coursing	9
Gap Spacing	9
Avoid "Crack-on-Crack"	9
Gable Ends/Rakes	10
Cutting	10
Colour and Width Variation	10
One-piece Hip and Ridge Application: Hip and Ridge Preparation	10
Ridge Vent Application	10
DaVinci One-piece Hip and Ridge Caps Installation	10
Valleys	11
Flashing	12
Ventilation	13
British Standard (BS) 5250 Ventilation Guidelines	13
Guidelines for Low-level Roof Ventilation	14
Guidelines for High-level Roof Ventilation	15
Quick Reference	16

Please note: the diagrams in this guide are for illustration purposes only, actual sizes/placement may vary from those shown. If in doubt, please contact your local area manager for advice, or contact our technical department: +44 (0)1482 880478.

– Product Information –

No Special Tools Required

- Hand fastened (hammered) or fastened with a nail gun.
- Sharp utility blade or a standard circular saw.
- Tape measure, hammer or nail gun, straight edge and pry bar.
- Chalk line with blue chalk (do not use red chalk).

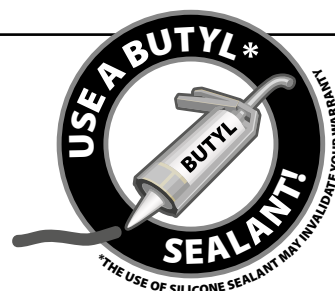

Storing the Product

For proper installation, the shakes need to be stored on the original pallet on a flat surface. Proper storage of the product at the job site is important. Do not double stack pallets!

Conditions: Perform work when existing and forecasted weather permits. Work should be performed in a safe and professional manner and when ambient weather conditions are within the limits established by Tapco Roofing Products.

Storage: Select Shake should not be stored on roof decks in such a manner as to over-stress and/or damage the deck and supporting structure.

Cold Weather Installation: Shakes should be stored in original packaging in a storage facility where the temperature meets or exceeds 7°C. Use protective coverage over all pallets while being temporarily stored on-site. Roof shakes must be conditioned at a temperature no lower than 7°C for twenty-four (24) hours prior to use. Shakes may be installed at temperatures as low as 0°C but must be hand fastened, the use of a pneumatic gun below 7°C will result in cracking and webbing in the fastened area. Be sure to follow the manufacturer's installation requirements for all underlay and any other applications. Comply with any and all local building code requirements. **Note of Caution:** The shakes can be slippery under certain conditions and job site safety procedures should be enforced.

Product Description

DaVinci polymer shakes are carefully engineered to provide the authentic look of hand-split shakes with dramatically increased durability and resistance to fire and impact. Special care has been taken to make the product easy to install. By following these instructions, and using good installation practices, you will be assured a quality installation.

WARRANTY:	40 Years	ROOFING BOARD:	Recommended 0.7" (18mm) OSB. Min. 15/32 (12mm)
WEIGHT (SELECT SHAKE):	8" Shake: 0.6 kg, 10" Shake: 0.8 kg	MINIMUM PITCH:	15° (Fully Boarded only).
WEIGHT (RIDGE & HIP):	1 kg	MAXIMUM PITCH:	70° (Fully Boarded only).
DRILLING:	No drilling required	SORTING:	No sorting required.
PACKAGING (SELECT SHAKE):	Pallet: 1056 Shakes (933 kg) Bundle: 22 shakes (19.42 kg) 11 Shakes of each width in every bundle.	ADHESIVES:	An adhesive for Polyethylene compounds is needed, PERMA-BOND® TA4605 or TA4610 is recommended. DO NOT glue tiles to the roof deck!
ROOFING MEMBRANE:	Recommended use of impermeable (non-breathable) Type HR roofing membrane.	CUTTING:	Fine-toothed handsaw, jigsaw, circular saw, or sharp utility blade.
FIXING:	Large 3/8" (10mm) diameter head, galvanised 1½" (40mm) by 0.1" (2.5mm) steel nails (using hammer or nail gun). Longer 2½" (65mm) nails are required for fixing ridges and hips. 4" (100mm) nails are required if using the RidgeMaster/HipMaster ventilation systems. Corrosion-resistant fasteners are always recommended, especially in coastal areas. In Scotland we recommend the use of Stainless Steel nails for fixing. We recommend Bostitch CR4DGAL Galvanised Roofing Coil Nails (38mm) for use in nailing guns, compatible with Bostitch RN46K-1-E & RN46K-2-E nailing guns and most other roofing coil nailers (but do check the manufacturer specifications).		

The shakes are manufactured from multiple natural patterns and measure nominally 21¾" (553mm) in height with 10" and 8" (254mm and 203mm) widths. The 10" width shake has a groove to simulate further 4" and 6" (102mm and 152mm) width shakes (which can also be cut down the groove into these widths as individual pieces). Select Shakes' finished look therefore creates the appearance of 4", 6", 8", and 10" wood shakes.

IMPORTANT:

Advice from our technical department should be sought when installing on high buildings and/or in exceptionally windy areas. Telephone: +44 (0)1482 880478.

SELECT SHAKE

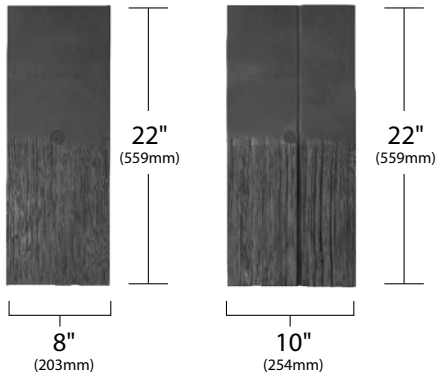

Finished look creates the appearance of 4", 6", 8", and 10" wood shakes

STARTER TILES

Starter (or Eaves) Tiles **MUST** be fitted. 3.5 tiles per linear metre

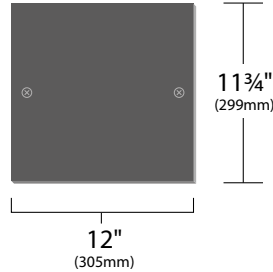

RIDGE & HIP CAPS

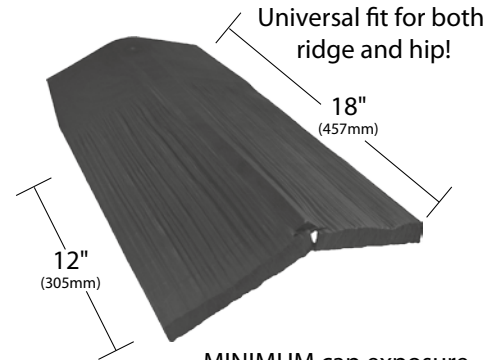

Universal fit for both ridge and hip!
MINIMUM cap exposure (measured from front of cap) should be set at 12" (305mm)

Ratings and Certification

Ratings & Certification			
TESTING	FINDINGS	TESTING	FINDINGS
Fire Rating:	BS EN 13501-5 : 2016 BROOF(t4)	Freeze/Thaw Cycle:	No damage or cracking after 300 cycles
Hail Rating:	Class 4 UL 2218	Water Absorption:	No appreciable weight gain
Wind-driven Rain/Uplift:	BRE EN 15601 & Miami Dade TAS-110 (110mph)	Water Permeation:	Impermeable
Accelerated UV Exposure:	ASTM G 155-13, 5000 hours Xenon Arc	Temperature Cycling:	No cracking deformation or expansion

Coverage	
PITCH:	15° to 70°
EXPOSURE:	Straight Tile Effect* Min. 9" (230mm) Staggered Tile Effect* Min. 10" (254mm)
SHAKE M²:	20 Shake Tiles per Square Metre
RIDGE/HIP CAPS:	3.3 Ridge/Hip Caps per Linear Metre
STARTER:	3.3 Starter Tiles per Linear Metre

BBA APPROVAL INSPECTION TESTING CERTIFICATION
CERTIFICATE No. 20/5765

BBA certification is recognised by architects, building planners, Local Authorities, contractors and inspectors as the leading impartial product approval and certification body in the market. BBA certificates are awarded to products in the construction sector after having passed a series of comprehensive and rigorous assessments which are tailored to the individual needs of the manufacturer and in line with building specification guidelines.

* The minimum recommended pitch and lap may be influenced by special circumstances, please contact our technical department for advice.

Leadwork

All lead used on the roof structure **must** be coated with Patination Oil to avoid the Select Shakes becoming stained via lead oxide run-off from untreated leadwork as the lead reacts with rainwater which coats the shakes.

Note: The choice of metals and fasteners should be consistent in material. Extended-life type materials should always be used for longevity of the roof system. Tapco Roofing Products does not warrant third-party metal components and accessories.

Recycling

DaVinci Select Shake is 100% recyclable, but is not marked with a recycling symbol/logo and so the contractor should contact a local recycler to make the necessary arrangements, stating that the product is "Polyethylene (PE)" plastic. If there is any difficulty in locating a recycling facility, please contact us as it can be returned to our facility (at cost) to be recycled. Note that local skip hire companies will send the product to the correct recycler.

BS 5250 Guidance on Roofing Membrane/Underlay

DaVinci Select Shake roofing shakes are classed as **insufficiently air-open** products and therefore, following the guidance within BS 5250, a **vapour impermeable (HR)** roof membrane/underlay should be used. Tapco Roofing Products recommends *Protect Wunderlay* for DaVinci Select Shake (other impermeable products can be used) and offers the following guidance:

Air Permeability

The detail below explains how a vapour permeable (LR) roofing membrane allows water vapour to escape the structure and requirements for ventilation of the counter batten space when using a roof covering that is insufficiently air-open.

Roof coverings and batten space ventilation using vapour permeable underlays (type LR)

Where vapour permeable underlays (type LR) are used in both cold and warm roofs to contribute to the control of condensation, they do so by allowing water vapour to escape through the material by diffusion. It is important that this water vapour can escape through the roof covering to atmosphere from the tiling batten space. BS 5250 defines the level of air openness required of the roof covering and the test method. Traditional concrete and clay tiles should be sufficiently air open, but advice should be sought from the roof covering manufacturer/supplier.

Roof covering sufficiently air-open

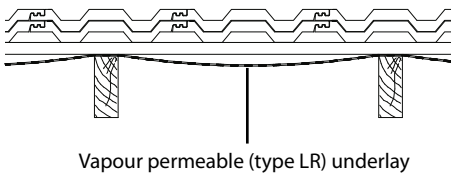

Roof covering insufficiently air-open

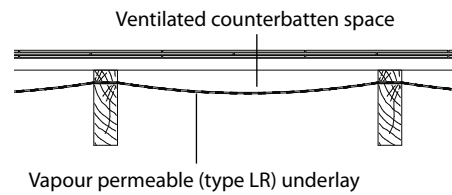

For roof coverings that do not meet the required air openness, provide a counterbatten space at least 25mm deep, with ventilation of 25 000mm²/m at eaves or low level and 5000mm²/m at ridge or high level. This is in addition to the ventilation already specified for cold and warm roofs.

With impermeable underlays (type HR) this ventilation is unnecessary as there will be relatively little moisture transfer from within the building to the batten space.

Cold Roof Applications

When installing DaVinci Select Shake onto either battens or OSB a **vapour impermeable (type HR)** roof membrane/underlay should be used. When installing directly onto OSB, ventilation in accordance with BS 5250 to the loft void should be adhered to. Insulation should be installed on the horizontal ceiling below. To further enhance this construction, improving thermal performance of all insulation by reducing convection flow and help to avoid interstitial condensation risk within insulation in accordance with BS 5250, we would recommend installing an air barrier on the warm side of the insulation, a suitable product would be *Protect BarriAir* – an air barrier membrane with some vapour control properties.

Cold Roof: with large voids above horizontal insulation using impermeable underlays (type HR)

Vapour impermeable underlay = Figures are given in 000s of mm² per metre, e.g. 5 = 5000mm²/m

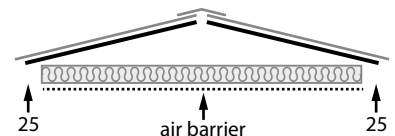
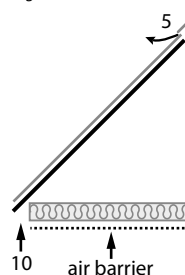
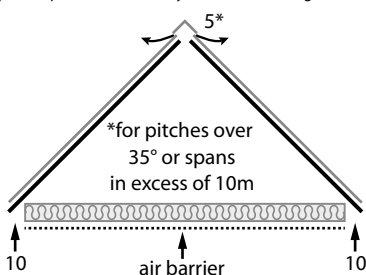

Warm Roof Applications

When installing DaVinci Select Shake directly onto OSB a **vapour impermeable (type HR)** roof membrane/underlay should be used. Insulation should follow the line of rafters, with a 50mm deep void between the top of the insulation and the underside of the underlay/OSB. This void to be ventilated in accordance with BS 5250. An air and vapour control barrier membrane to the warm side of the insulation must also be installed, we recommend the *Protect VC Foil Ultra* – low emissivity air and vapour control layer product.

Please note that the preceding is purely manufacturers guidance and should not supersede local building authority recommendations.

Warm Roof: with small or no voids above sloping insulation using impermeable underlays (type HR)

Vapour impermeable underlay =  Figures are given in 000s of mm² per metre, e.g. 5 = 5000mm²/m

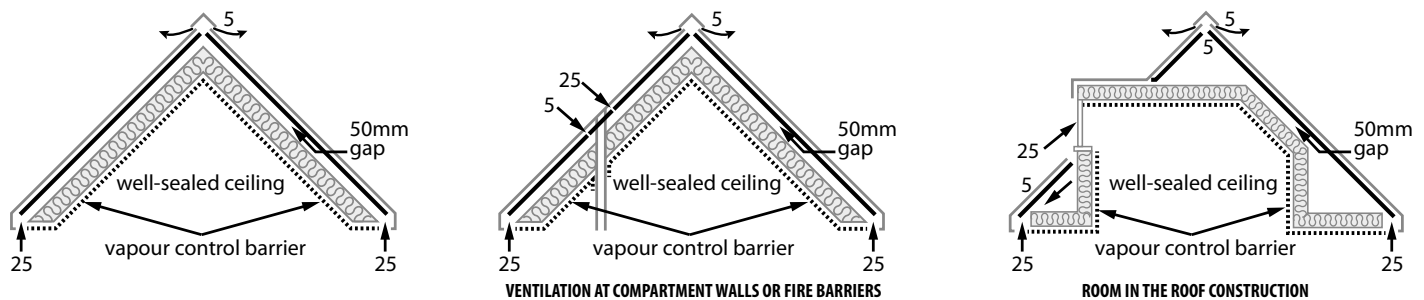

– Installation Guidelines –

Note to Installer

DaVinci Select Shake offers a 5/8" (16mm) thick profile, yet remains lightweight, because the shakes have an engineered rib structure. When cutting shakes for valleys or at overhangs such as eaves and gable ends, the ribbed support structure on the underside of the shake needs to be hidden by standard metal flashings.

Pay special attention to recommendations for accessories and installation at gable ends ("Drip-edge" below) and valleys (page 11).

Job Site Ready!

DaVinci shake bundles are delivered to the construction site pre-collated with shingle widths and color variations in the ordered blend. This pre-planned distribution produces the right aesthetic effect every time. Collated bundles also simplify installation and save time by eliminating hand sorting on the job site.

This information is provided for the use of professional roofing contractors. This Installation Guide does not supersede Local Authority Building Regulations which should always be followed. Tapco® Roofing Products does not warrant or have any responsibility for installation of its products. The Tapco Roofing Products Extended Warranty outlines the company's responsibilities for the roofing materials that it manufactures, please visit the Document Centre on our website for details.

Roof Deck

DaVinci Select Shake must be installed on a fully-boarded, smooth flat surface (OSB or plywood); recommended 11/16" (18mm), minimum 15/32" (12mm) thickness. It is necessary that all previous roofing materials be removed prior to installation of DaVinci Select Shake as imperfections in the roof deck may transmit through to the finished roof.

Drip-edge (Dry Verge & Gutter)

The use of a dry verge is recommended when installing Select Shake (Tapco Dry Verge CO2LPBL). Fit dry verge to the gable edge before fixing the Select Shake product. Dry verge will overhang the edge by 1½" (38mm) to form a drip edge and will also mask the edges of any cut shake. The first course and Starter course of Select Shake should oversail into the center of the gutter by 1½" (38mm).

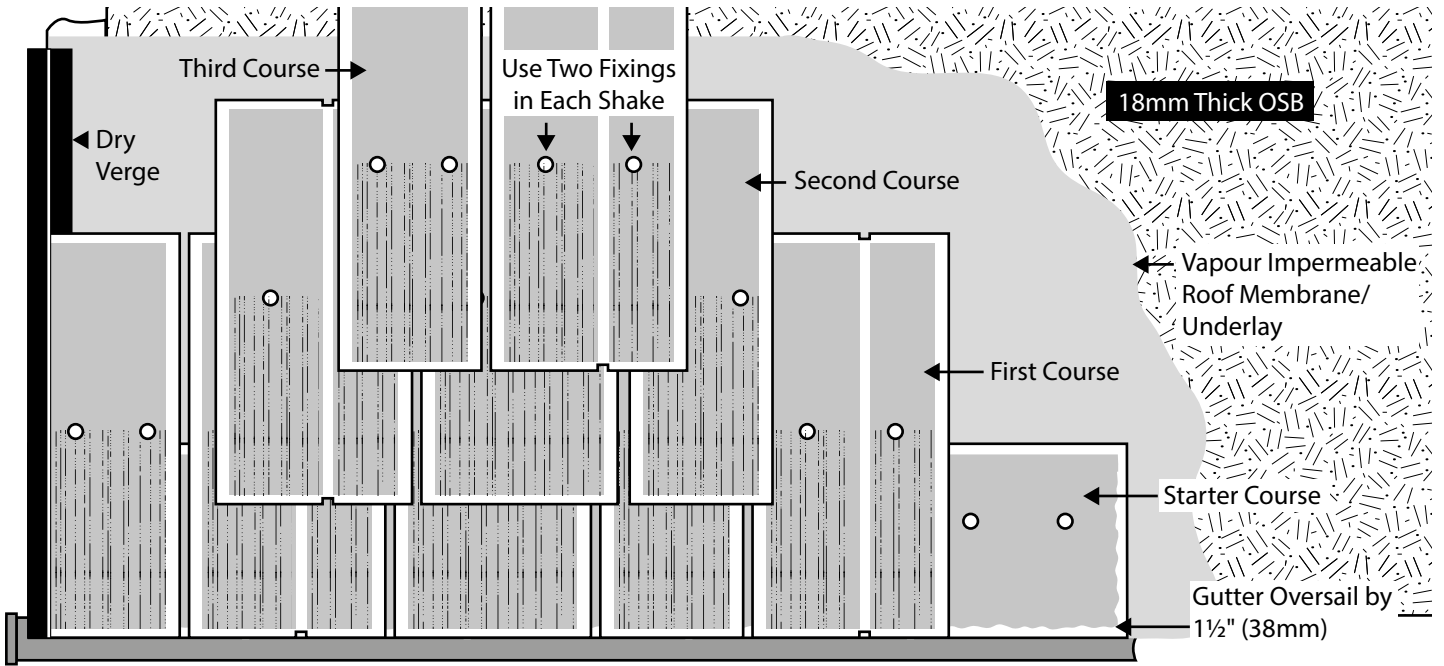

Roof Membrane/Underlay Use

The following instructions are just a guide, and standard roofing procedures should be applied. Apart from the lightness and ease-of-use that DaVinci Select Shake affords, there is very little difference between it and standard wood shake in a fully-boarded roof application. The **most cost-effective application** for Select Shake to OSB is to first use a **vapour impermeable** roof membrane/underlay, along with, we recommend, either an air barrier on the warm side of the insulation for Cold Roof applications or an air and vapour control barrier membrane to the warm side of the insulation for Warm Roof applications (see the "Roofing Membrane/Underlay" section on pages 5 & 6 for more details). Alternatively, a vapour permeable roof membrane/underlay can be used along with the application of counter battens on top of the membrane. The same vapour/air barriers are also recommended for Cold/Warm Roof applications using this counter batten method and a vapour permeable roof membrane/underlay.

The Different Roof Structures Using Vapour Impermeable and Vapour Permeable Membrane

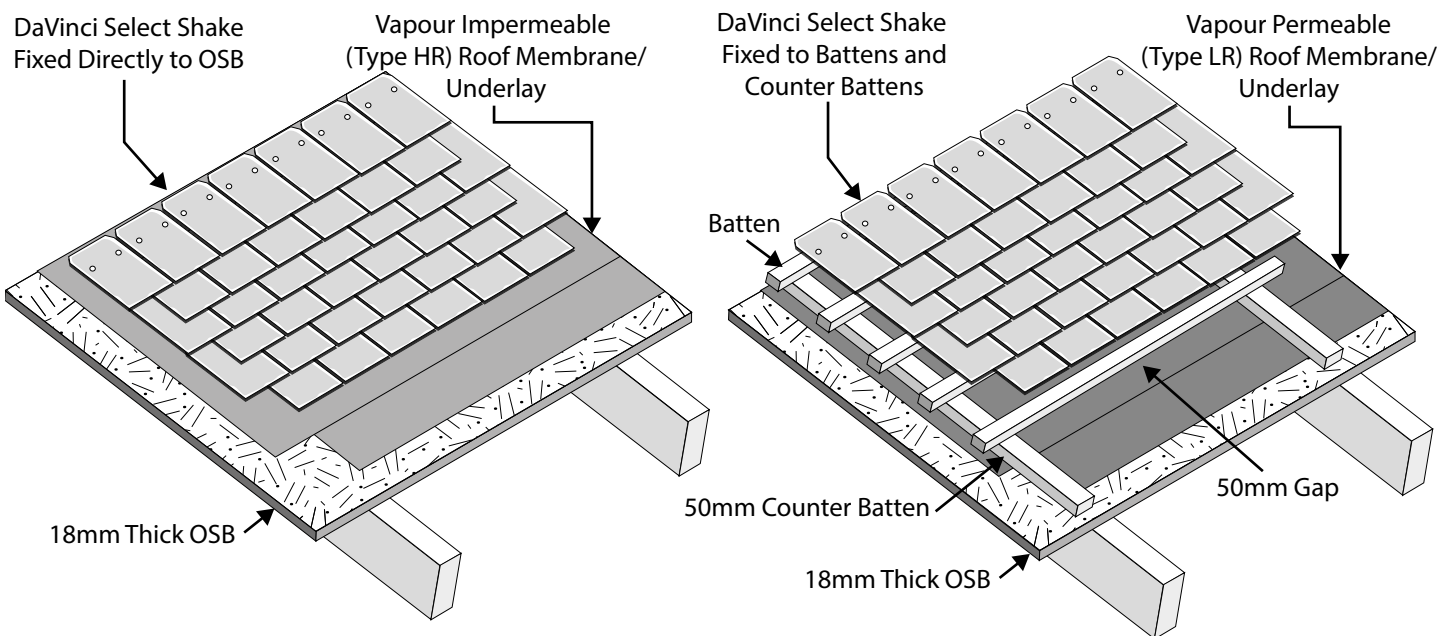

NOTE: when fixing onto battens as illustrated, only Straight Coursing of the Shake can be used

Fasteners

Large 3/8" (10mm) diameter head, galvanised 1½" (40mm) by 0.1" (2.5mm) steel nails (using hammer or nail gun). Longer 2½" (65mm) nails are required for fixing ridges and hips. 4" (100mm) nails are required if using the RidgeMaster/HipMaster ventilation systems. Corrosion-resistant fasteners, typically Stainless Steel, are always recommended, especially in coastal areas. In Scotland the use of Stainless Steel nails for overall fixing is recommended by Scottish Building Control.

Starter Course

Each starter tile should be installed so that it extends past the eaves roof edge by approximately 1½" (38mm). The starter tiles should be installed with the DaVinci logo on top. The starter tiles should be gapped/spaced 3/8" (10mm) apart as the tiles will expand when warm. Each starter tile should be nailed with two approved nails on a line approximately 6" (152mm) from the butt and ¾" (19mm) from the outside edge.

Getting Started

Use approved nails in each shake at-or-near nailing location shown on the shakes (see page 16). Nails may be placed lower than the indicators as long as the tile above it covers the nail. Once the starter tiles are in place, begin installing shakes in the lower left corner (or lower right corner for a left-handed roofer). The shakes should be flush with the starter tiles on the outer (rakes) and lower (eaves) edges. A minimum 3/8" (10mm) gap between shakes is recommended to allow expansion during warmer weather.

Two methods of installation are available:

1. **Straight:** in which the exposure of each shake is kept consistent
2. **Staggered:** in which the exposure varies by a maximum of 1" (25mm) on adjacent shakes

The exposure of DaVinci Select Shake is determined by the configuration or pattern that you wish to achieve, as the tiles can be fitted in either standard straight tile effect (as you would see in a roofing slate with uniform rows) or as a staggered tile effect (random fitment, as you would sometimes see on a natural cedar roof). The minimum tile exposure for a roof utilising the straight tile effect is 9" (230mm), and the minimum tile exposure for a roof utilising the staggered tile effect is 10" (254mm). Note that these are the **minimum** tile exposure measurements and tiles can be fitted less (but not more) than this, especially when utilising the staggered tile effect where you would want a more random pattern creating.

Note that the exposure on DaVinci Select Shake has to be manually set using either a tape measure or pre-cut-to-size timber batten.

As you progress up the roof, be careful not to damage shakes already in place. Put something, perhaps a piece of cardboard or cut shake, under toe irons (scaffolding brackets) to avoid scratching or marring the shake already installed below.

Straight Coursing

Install the shakes one at a time starting in the lower left hand corner if right handed, or lower right hand corner if left handed. The first course of shakes should be laid directly on top of the starter tiles with the butt of the shake flush with the butt of the starter tile. The shakes should be installed individually with two nails in or near the defined markers. The shakes should be laid individually with a rack type system, also known as rack-style, stair-stepping, or pyramiding; to prevent same size shake directly on top of another. The shakes should be laid with an approximate 3/8" (10mm) gap between each shake. The gaps between shakes on adjacent courses should offset by a minimum 1½" (38mm). To assure proper horizontal alignment we recommend that chalk lines be snapped frequently. These chalk lines should be placed on the underlay so that the shakes are aligned by the tips of the tiles rather than the butts.

Chalk lines should be snapped on underlay with the tips of the shakes following the lines. Do not snap lines on Select Shake or use red chalk as the chalk may permanently discolor the shake.

Straight Coursing on Select Shake at a 10" (254mm) Exposure

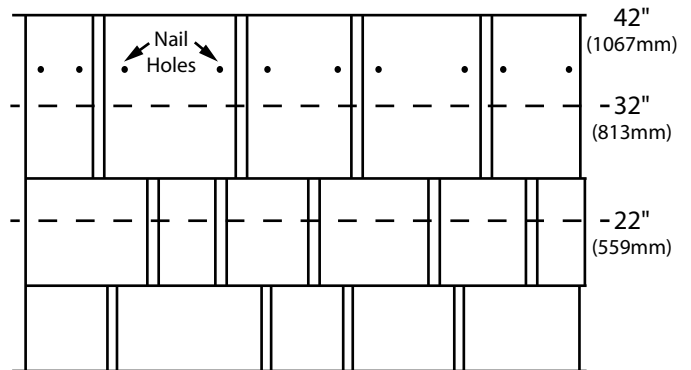

Staggered Coursing

DaVinci Select Shake may be staggered using a similar method as Single-Width and Multi-Width Shake. This will mean that it will appear that two tiles are pulled down at once in some instances. When necessary the tiles with false breaks may be cut down the false break area to create two distinct 4" and 6" width shake tiles.

Select Shake tiles do not have alignment indicators so the courses should be aligned with a chalk line at the tip of tile or alternately with shake liner.

Staggering the courses is accomplished by laying the shakes in 9" (229mm) courses with every other shingle lowered 1" (25mm).

An example of how to accomplish this is as follows:

Step 1: Lay the first course of shakes flush on top of the starter.

Then snap a horizontal line 9" above the tips of the shakes you just installed or 31" from the eave line (butt of the shake you just laid).

Step 2: The first shake on second course should be installed putting the tip of the shake on the chalk line. The next or adjacent shake should be 1" below the line. The third shake should be on the line; the fourth shake should be below the line. This continues in the same pattern all the way across the roof one shingle tip on the line and the next 1" below the line.

Step 3: Snap another horizontal line 9" above the line you chalked in Step 2 or 40" above the butt of the first course of shakes. Start laying shakes as in Step 2 with the first shake tip on the line and the next shake tip about 1" below the line.

Step 4: Continue up the roof in this manner.

Tip: 10" tiles with a false keyway can be cut along the false keyway and used as two individual pieces. This will create a more random look. Cut the keyway with a knife vs. a saw for a cleaner cut.

Chalk lines should be snapped on underlay with the tips of the shakes following the lines. Do not snap lines on DaVinci Shake or use red chalk as the chalk may permanently discolor the shake.

Gap Spacing

The recommended gap spacing between shakes is 3/8" (10mm) with a **minimum** 3/16" (5mm) gap required. The number of shakes per square metre for DaVinci Select Shake is based on the assumption of 3/8" (10mm) spacing between the shakes. If the spacing is less, more shakes per square metre will be required.

Avoid "Crack-on-Crack"

The gap between two shingles in one course should always line up 1 1/2" (38mm) or more from the gap between two shakes in the course below. When possible, the same rule should apply to false breaks, although this is for aesthetic reasons and will not affect the performance of the roof system.

Correct ✓

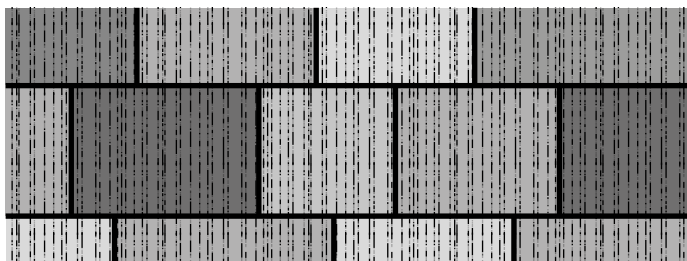

Incorrect ✗

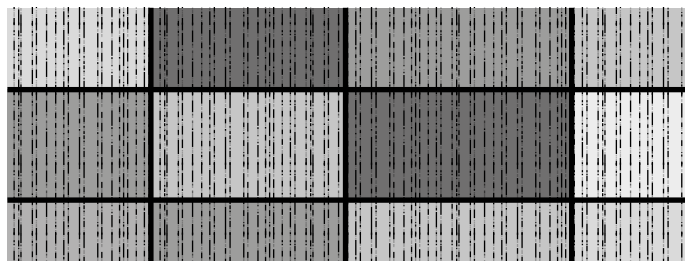

Staggered Coursing on Select Shake at a 9" (229mm) Exposure

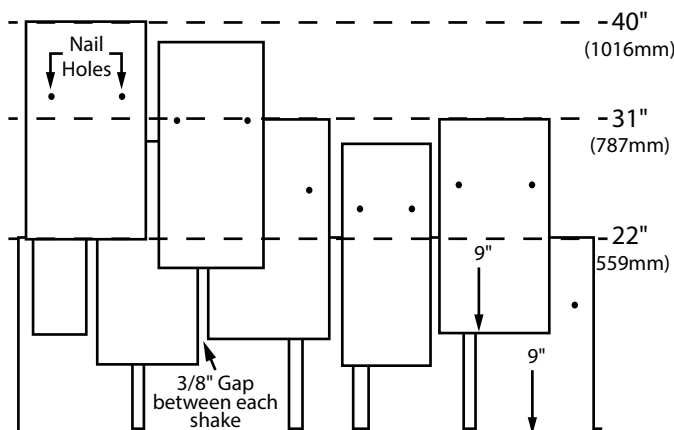

Gable Ends/Rakes

If fitting Select Shakes at gable ends without using a dry verge, shakes should be cut so that the factory edge faces out on the gable end. When necessary the tiles with false breaks may be cut in the false break area to create two distinct tiles.

Cutting

DaVinci Select Shake may be cut with a utility knife and straight edge or a hand-held (close-toothed) plastics saw. It may also be cut effectively with a circular saw. Carbide tooth blades are recommended for maximum blade life.

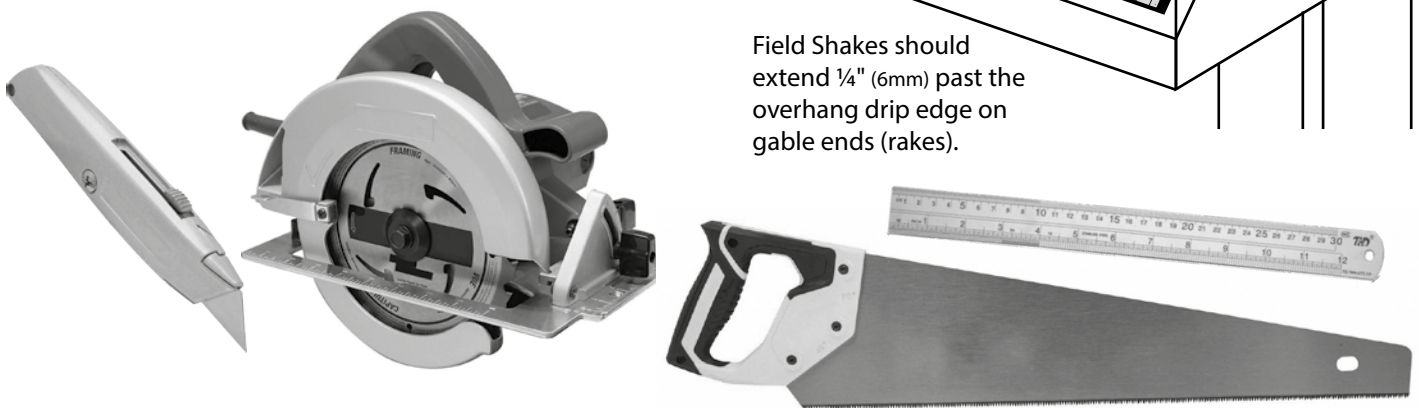
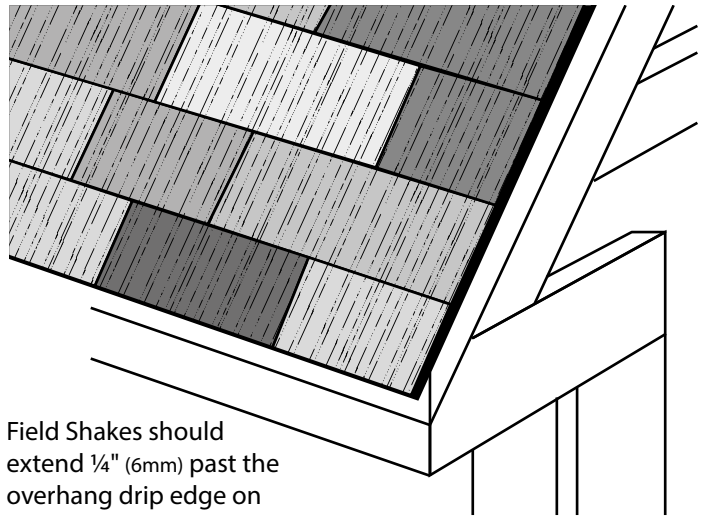

Colour and Width Variation

Davinci Select Shake bundles are made up of 8 different shake (tile) shapes. Four of the tiles are 8" wide and four are 10" wide. Of the four 10" tiles, three have false breaks making them appear to be two different shakes and one of them is a 10" tile without a false break. We recommend that the shakes should generally be installed as they come out of the bundles. Keep in mind there must be 1/2" (38mm) side lap maintained and installation must be in a rack or pyramid style.

One-piece Hip and Ridge Application: Hip and Ridge Preparation

Select Shake uses the Bellaforté Shake One-Piece Hip and Ridge Cap. The one-piece hip and ridge caps have an optimum appearance when used on pitches of 45° or less. Steeper pitches may cause outside edge to lift and it is recommended the conventional two-piece hip and ridge method be used for pitches greater than 45°. Roofing nails that penetrate through the roof deck and exceed it by 3/16" (5mm) should be used.

Ridge Vent Application

If using a continuous ridge vent we recommend using either our RidgeMaster ventilation system or a rigid shingle roll-over type. Once the continuous vent is installed, prepackaged Bellaforté One-Piece Hip and Ridge Caps should be installed in accordance with the standard hip and ridge installation instructions below. Special caution should be used when cutting the decking at the ridge to assure adequate material for nailing for the ridge pieces.

DaVinci One-piece Hip and Ridge Caps Installation

The one-piece hip and ridge cap should be installed at a 12" (305mm) exposure. The tiles should be nailed once on each side about 3/4" (19mm) from the outside edge with 2 1/2" (65mm) roofing nails long enough to penetrate through the roof deck and exceed it by 3/16" (5mm). The hip and ridge should be nailed approximately 12 1/2" (318mm) from the butt of the tile, and 1/2" to 3/4" inch (13mm to 20mm) from the outside edge. When nailing, it is best to try to nail the hip and ridge through the butt of the field tile, not in the void below the butt. The nail may be raised up to an inch above the nailing circle if necessary. If the tile must be nailed in the gap below the butt of the field tile, don't drive the nail down so hard that it distorts the hip and ridge tile. A chalk line should be used on the hips to assure straightness. A shingle over type continuous ridge vent may be used if wanted. If continuous ridge vent is used, nails used to secure the hip and ridge tiles must penetrate through the decking and exceed it by 3/16" (5mm).

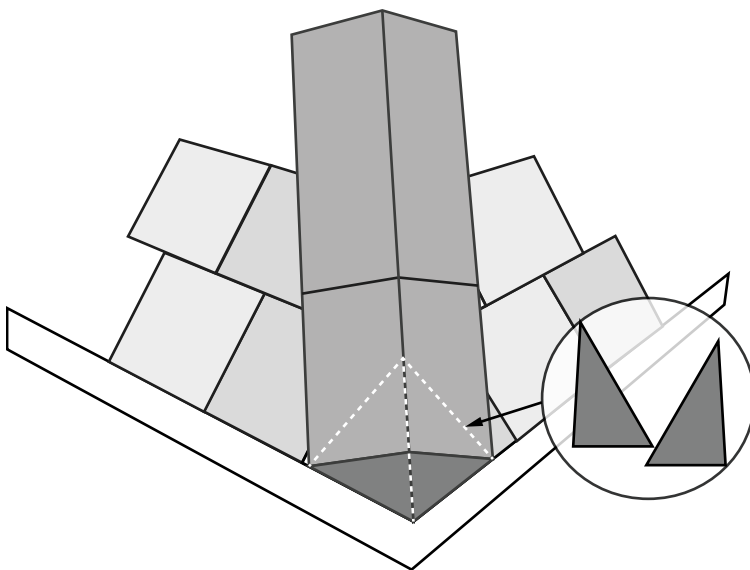
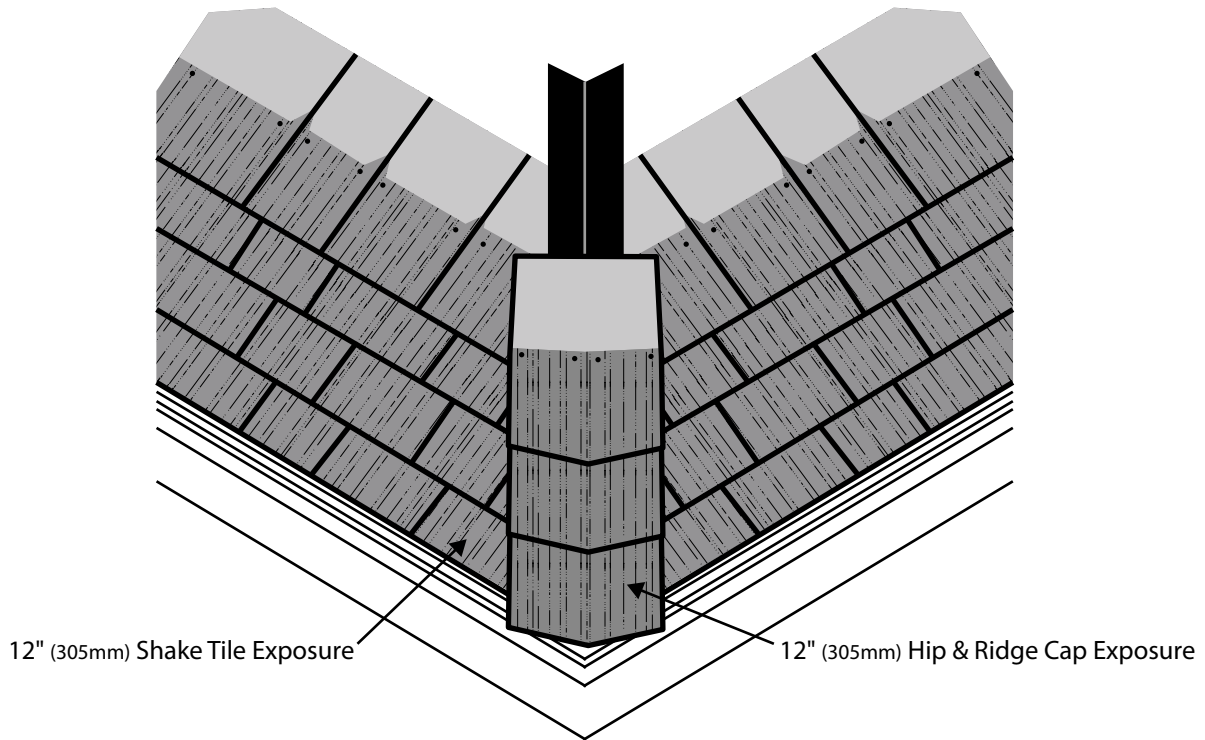

Hip Starter Application:

At the bottom of a hip, the hip and ridge cap may be cut on an angle so that the bottom edge may be installed parallel with the eaves. A piece of flashing or UV stable roofing material should be installed along the bottom 6" (152mm) of the hip in order to protect the area under the seam formed by the cut material. The cut hip and ridge cap is then assembled so that the two cut pieces are butted together to form the bottom piece of hip and ridge. Once these two tiles are in place, a full hip and ridge cap is installed and pulled down so the outside corners just reach the bottom of the roof.

Valleys

Because DaVinci Select Shake has a rib-structure on the underside, care must be used when installing Select Shake in valleys. Open or closed valley systems may be used with variants of each system. Whether installing an open or a closed valley system, valley metal can be made from 24" (610mm) stock of copper, minimum 0.5mm thick aluminum, or minimum 0.37mm width clad steel if you prefer to make your own. It is recommended to use self-adhered membrane in valleys if possible/available. Alternately, pre-formed ABS plastic or GRP valley accessories, available from most roofing retailers (both over-the-counter or online), can be used, as well as forming valleys out of lead (or lead substitute) in the traditional way.



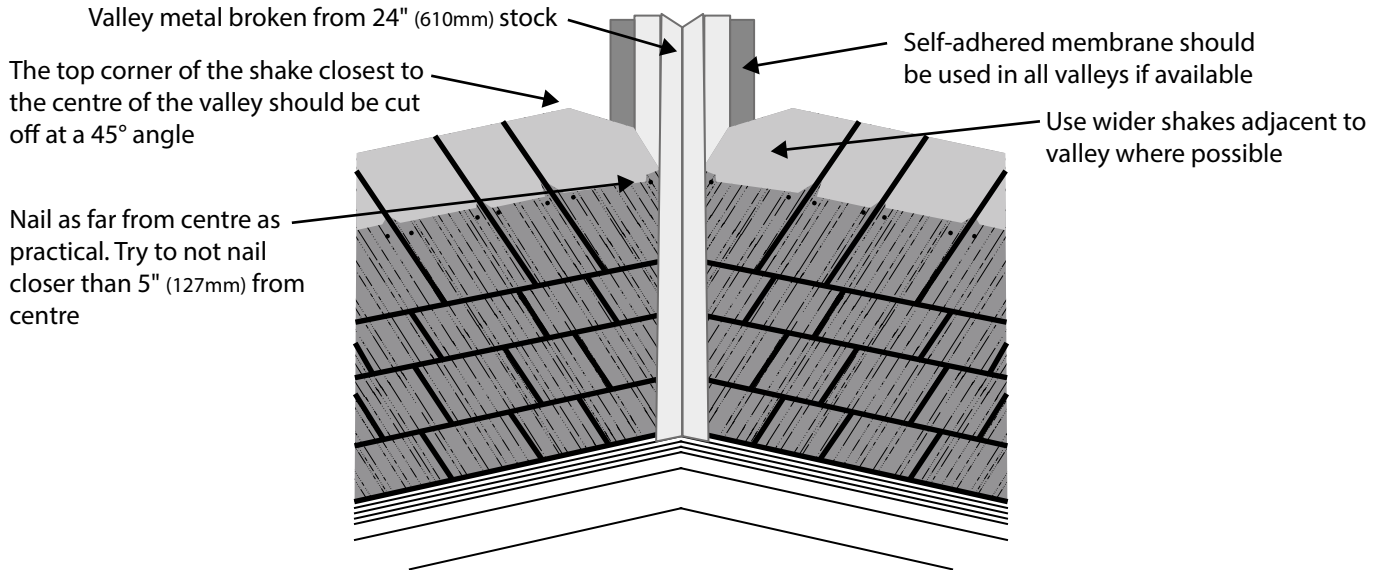

Flashing

Flashing should be used in all areas where the roof abuts a vertical wall, dormer, chimney, skylight, roof window or other structural protrusions.

Use the step flashing method, with lead or lead substitute flashing. The flashing should extend at least 4" (102mm) up vertical walls.

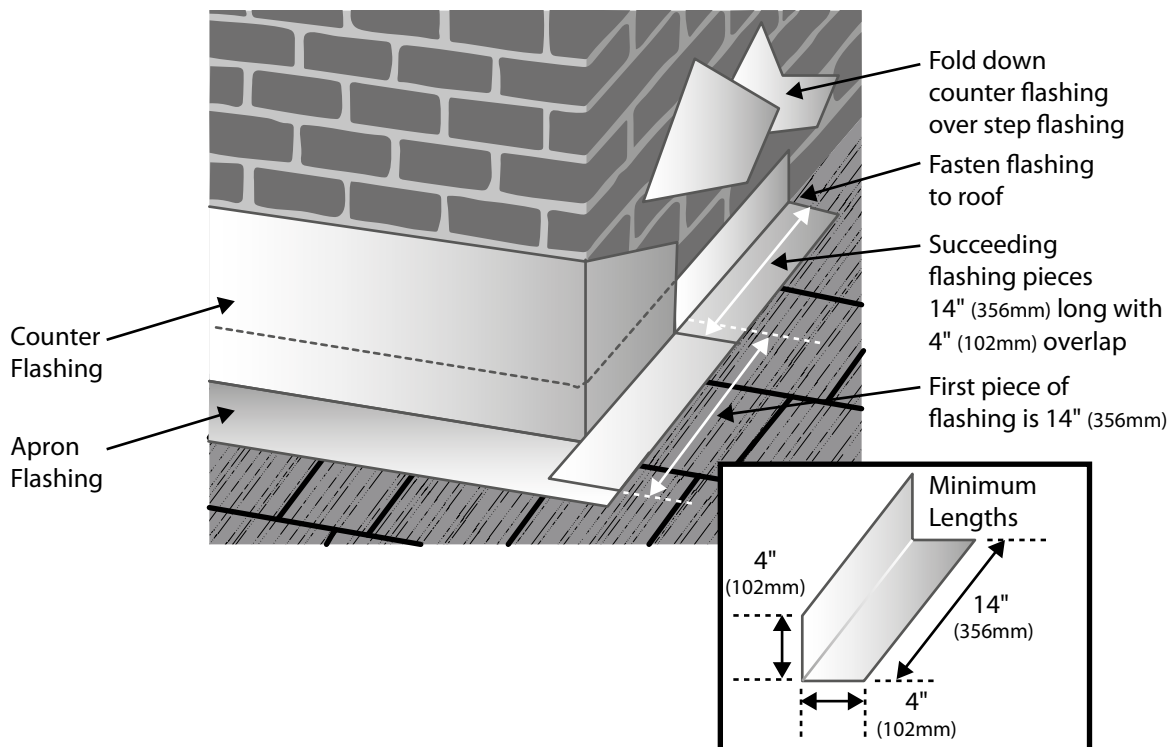

- Ventilation -

British Standard (BS) 5250 Ventilation Guidelines

BS 5250 stipulates guidelines with regards roofing ventilation and condensation. Its primary concern is to eradicate condensation, which is mainly generated from within the home, from reaching and destroying the roof structure timber. Even when timber is not used in the roof construction, the vapour still needs to be properly extracted to prevent it from affecting other parts of the dwelling place.

As with many other roof coverings, DaVinci Select Shake is classified as an **“Insufficiently Air Open”** product, meaning that water vapour cannot vent to atmosphere directly through the tiles, and so provision must be made to ventilate the roof space to move the water vapour from **inside to outside** the property. Proper ventilation is an **essential** part of modern-day roofing.

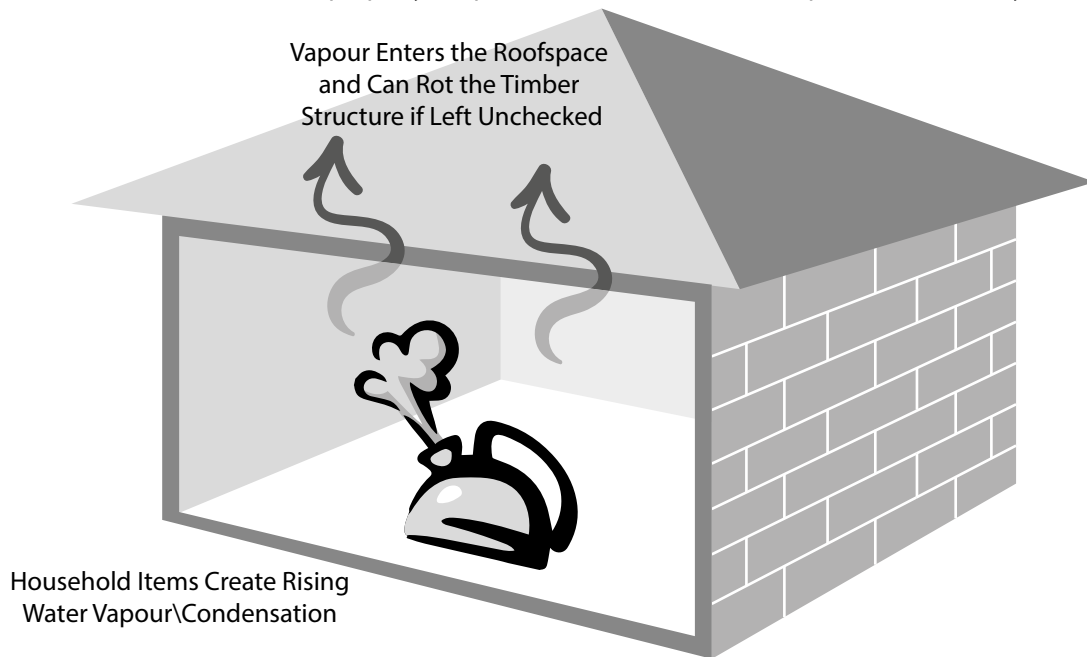

Standard Roof Ventilation

BS 5250 requires all roof structures to be **ventilated** at both **low-level** (air moving into the roof), which is typically at the eaves or soffit and at **high-level** (air moving out of the roof), which is typically at the ridge/hip, abutment, or with the use of fixed ventilation units.

Obstructions such as dormers, valleys, roof windows, compartment walls, fire barriers and changes in pitch create **separate voids** below the roof slope. Ventilation openings should be provided to **each void** at high and low level.

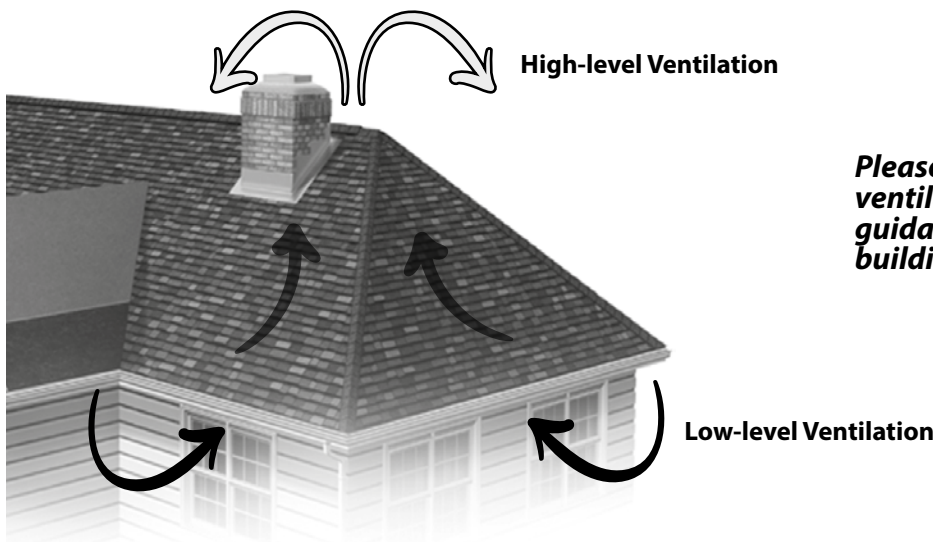

Please note that this chapter on roof ventilation is purely manufacturers guidance and should not supersede local building authority recommendations.

Guidelines for Low-level Roof Ventilation

Tapco Eaves Ventilation Kits are recommended for low-level roof ventilation in both warm roof and cold roof construction. On a **warm roof** a 50mm void following the line of the rafters should be maintained and on a **cold roof** the loft space needs to be ventilated. These kits achieve this while keeping debris and insects from blocking the airflow. The **TEVK10** and **TEVK25** Eaves Ventilation Kits install continuously along the eaves and provide ventilation openings of **10,000mm²/m** (cold roof) and **25,000mm²/m** (warm roof) respectively. This kit consists of 10mm or 25mm over-fascia vents and eaves skirts in a 6-linear-metre pack. The **TEVK10** (10mm kit) also consists of a 300mm x 6m **Rafter Ventilation Roll** since most cold roof installations are felt & batten construction. Note that the **TEVK25** (25mm kit) does not include a Rafter Ventilation Roll, this will be required to be purchased separately if using felt & batten construction.

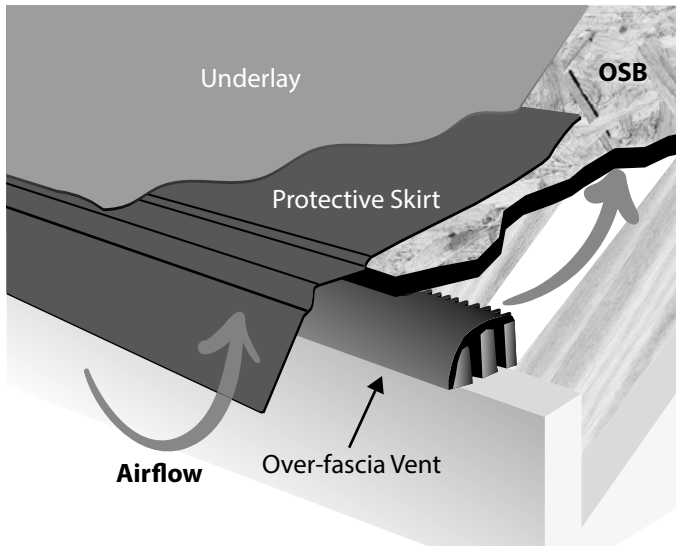

Fully-Boarded Roof

The **over-fascia vent** is fixed onto the fascia board and sits underneath the OSB or ply. The **protective skirt** covers the vent and roofing membrane is then laid on top of the skirt and the rest of the roof. Airflow comes in from the underneath of the vent and flows up the roof underneath the OSB/ply.

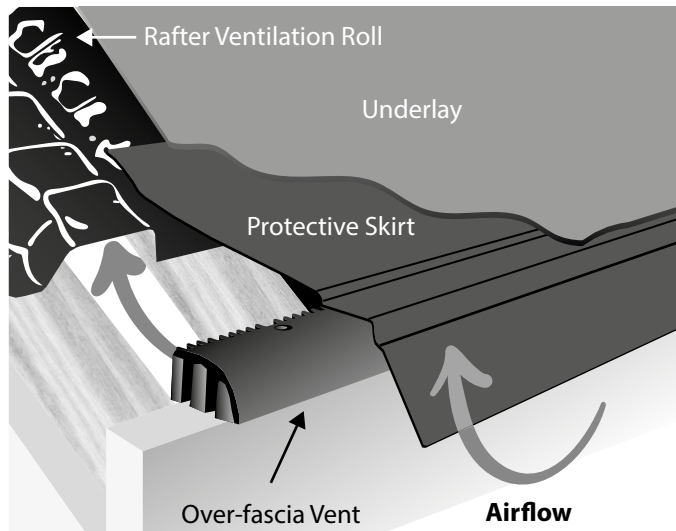
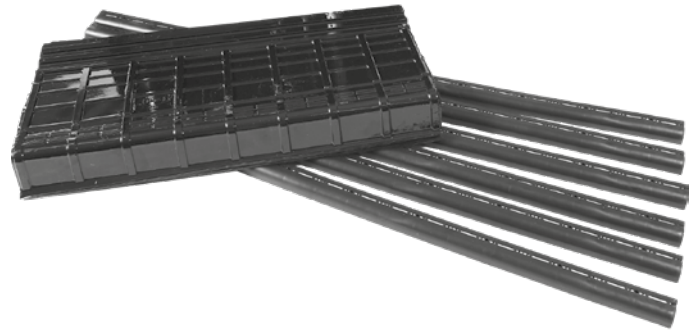

Felt & Batten Roof

The **over-fascia vent** is fixed onto the fascia board and the **protective skirt** fits on top to protect the vent. For felt & batten installations we advise fitting a **Rafter Ventilation Roll** along the span. The roofing membrane sits on top and battens can then be fixed.



**Rafter Ventilation Roll
(Felt & Batten Roof
Construction)**

**TVK10 Eaves Ventilation Kit
(Cold Roof Application)**

Guidelines for High-level Roof Ventilation

High-level ventilation is needed for the low-level airflow to exit and vent water vapour to atmosphere. Cross-flow ventilation (low-level to low-level) has been shown to be inadequate as standard air pressure is too low to adequately vent water vapour in this way. The use of the **RidgeMaster Plus** ridge ventilation system and/or **HipMaster** hip ventilation system is recommended in both warm roof and cold roof construction when installing DaVinci Select Shake. The **Tapco Abutment Ventilator** is again recommended in both scenarios for roofing abutments (such as lean-to roofs).

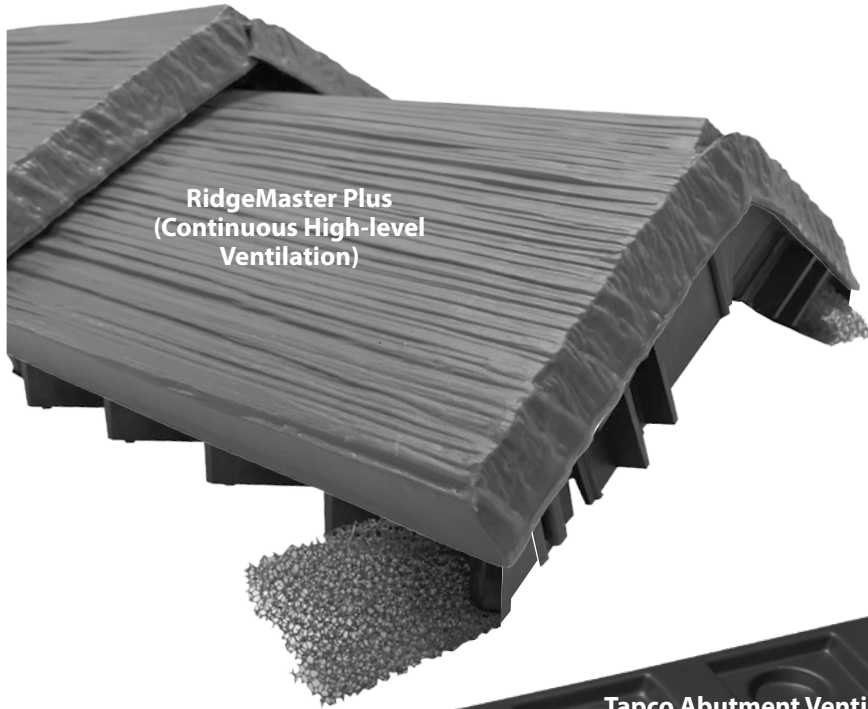

RidgeMaster Plus
(Continuous High-level Ventilation)

RidgeMaster Plus & HipMaster

The **RidgeMaster Plus** and **HipMaster** ventilation systems are manufactured specifically to fit underneath our **DaVinci Select Shake Ridge & Hip Caps** for continuous ridge and/or hip ventilation. These units provide **22,000mm²/m** high-level airflow and are easily fixed in place by nailing or screwing directly through the ridge & hip caps. Each unit covers 1.2 linear metres, is unobtrusive when fixed and contains baffles to prevent debris and insects.

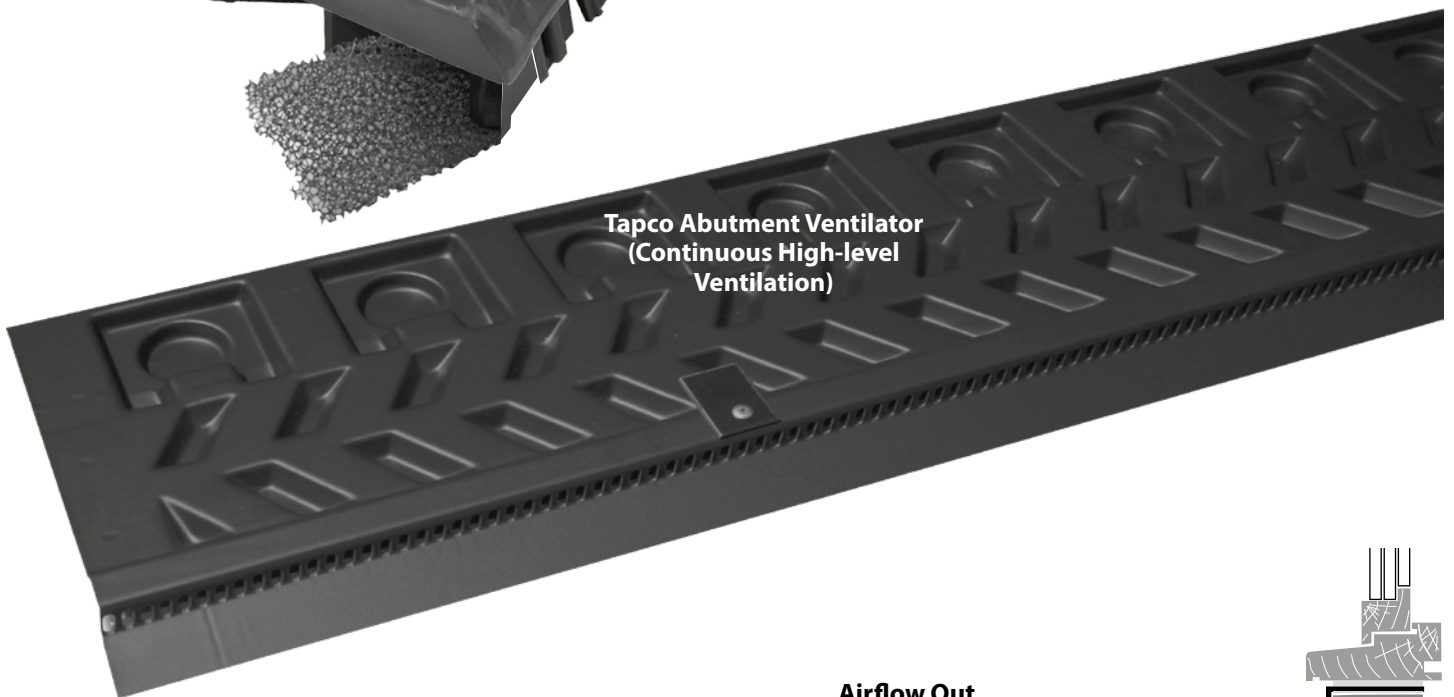

Tapco Abutment Ventilator
(Continuous High-level Ventilation)

Tapco Abutment Ventilator

The **Tapco Abutment Ventilator** provides unobtrusive **5000mm²/m** high-level ventilation in conjunction with lead roll details on shake roofs. It is particularly useful in top edge abutment details where there is limited vertical clearance. The ventilator provides full compliance with **BS 5250 Control of Condensation in Buildings**, the primary means to comply with **Building Regulations** in the UK as well as providing driving rain and large insect resistance.

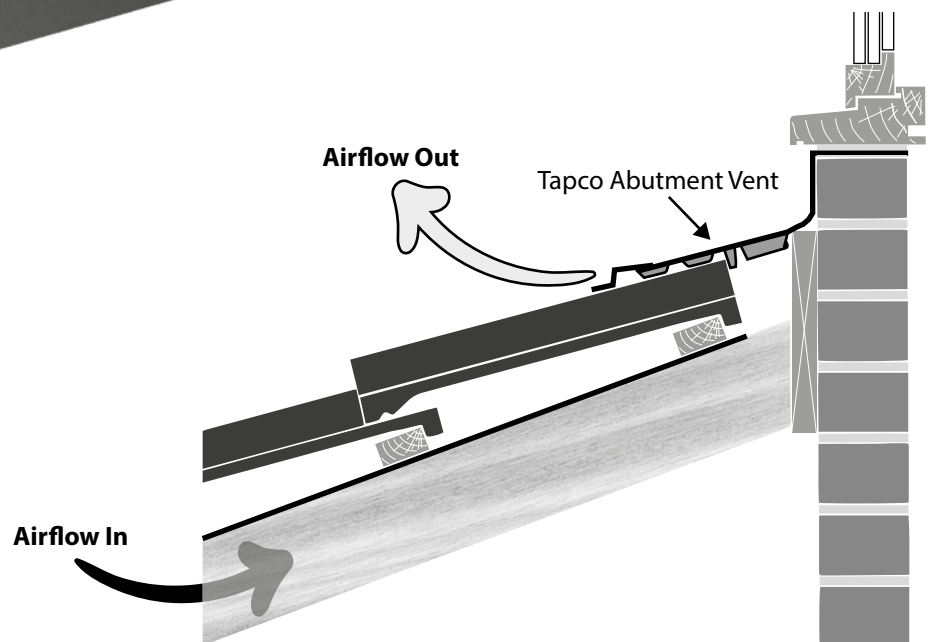

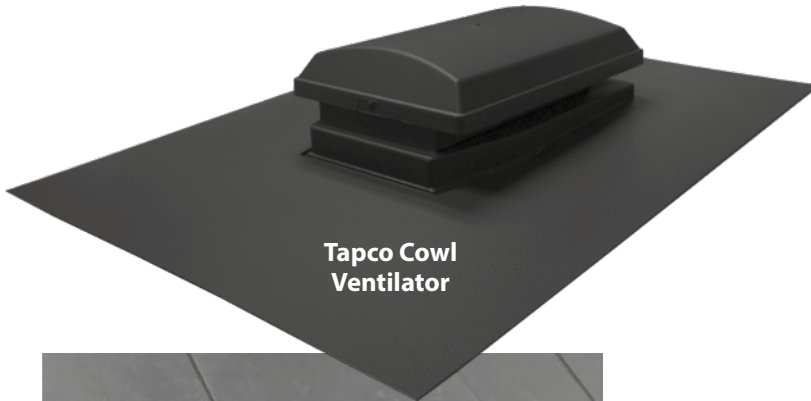

Tapco Cowl Ventilator

Tapco Cowl/Soaker-style Slate Ventilators are designed to ventilate through the roof slope and form an integral part of a slate or tile roof covering. They can be used at low or high level where the roof construction does not allow eaves or ridge ventilators to be used, or where complex roof shapes do not allow effective cross ventilation. **Cowl Slate Ventilators** are suitable for roof pitches from 15° to 90°. They are available in **10,000mm²/m** and **20,000mm²/m** airflow units.

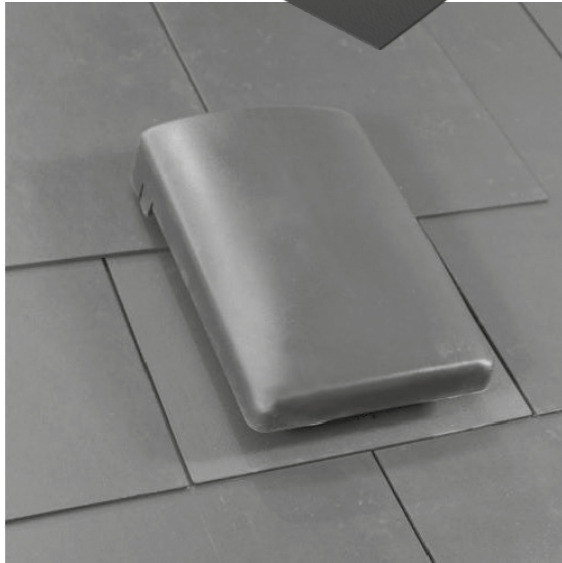

Pipe Adapters

Pipe Adapters are also available to allow **Inline** or **Cowl Ventilators** to be used in conjunction with a standard round vent pipe. This converts the vent to a soil pipe fitting and/or mechanical extract terminal.



Inline Vent Pipe Adapter



Cowl Vent Pipe Adapter

Quick Reference

- Don't overdrive or install nails at an angle.
- Always leave a gap between all tiles.
- Vertical, always install up the roof and not just one row across the roof at a time.
- Install over a clean OSB/plywood deck only.
- Never use red chalk.
- Cut edges always go to the inside along rake edges or gable ends if not using dry verge to cover.
- Snowguards can be installed in any snow-prone area if required.
- Always ventilate the roof in adherence to BS 5250 guidelines.
- **Any instructions in this guide should not supersede local building authority recommendations!**

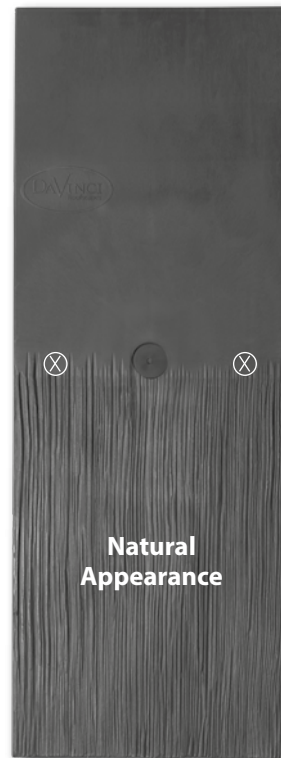

Nailing Guides